

*MOTOROLA  
COMMERCIAL SERIES*



**MOTOROLA**  
*intelligence everywhere™*

**BASIC USER GUIDE**  
**CP160**



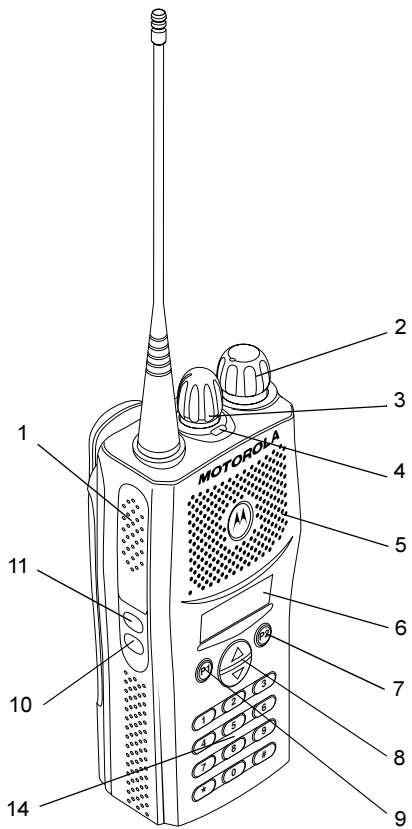

**CP180**

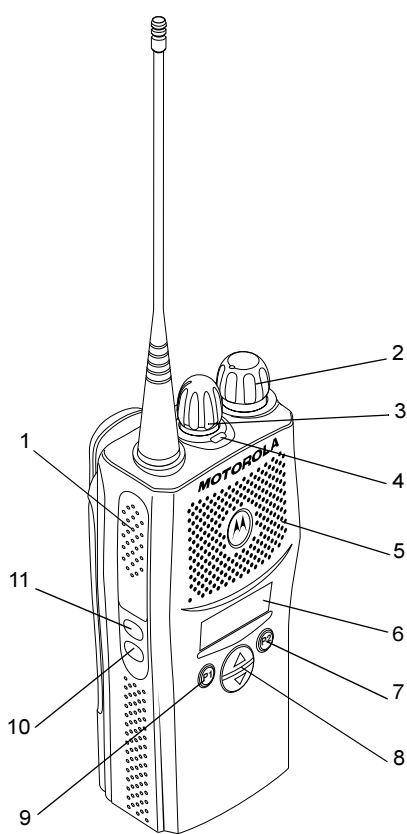

**CP160**

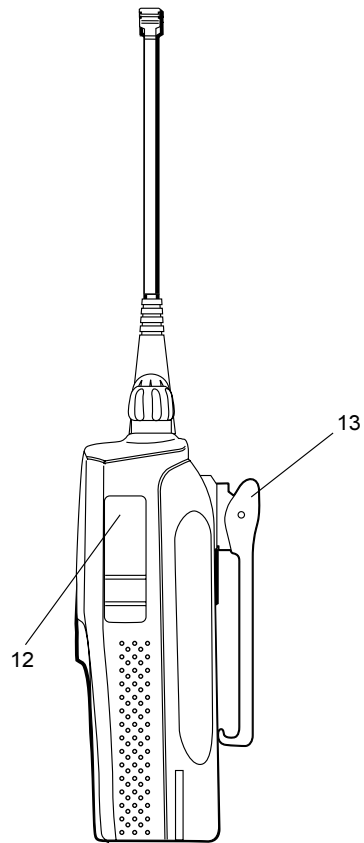

# BASIC USER GUIDE

## Contents

<b>Radio Overview</b> .....	<b>2</b>
Radio Controls .....	2
Audio Signal Tones .....	3
Programmable Buttons .....	3
Menu Buttons (CP160/CP180) .....	4
Menu Navigation Chart (CP160/CP180) ..	5
LCD Display and Icons (CP160/CP180) ..	6
<b>Getting Started</b> .....	<b>7</b>
Battery Information .....	7
Accessory Information .....	8
Turning the Radio On-Off .....	11
Adjusting the Volume .....	11
Radio On Message (CP160/CP180) .....	11
Radio On Indicator (CP140) .....	12
Selecting a Radio Channel .....	12
Receiving a Call .....	13
Sending a Call .....	13
Making a Selective Call (CP160/CP180) ..	14
Receiving a Selective Call .....	14
Cancelling a Call .....	14
Ending a Call .....	14

# SAFETY INFORMATION

This user guide covers the operation of the CP140, CP160 and CP180 Portable Radios.



**Caution**

Before using this product, read the operating instructions for safe usage contained in the Product Safety and RF Exposure booklet 6864117B25\_ enclosed with your radio.

## ATTENTION!

This radio is restricted to occupational use only to satisfy ICNIRP RF energy exposure requirements. Before using this product, read the RF energy awareness information and operating instructions in the Product Safety and RF Exposure booklet (Motorola Publication part number 6864117B25\_) to ensure compliance with RF energy exposure limits.

## Computer Software Copyright

The products described in this manual may include copyrighted computer programmes stored in semiconductor memories or other media. Laws in the United States of America and other countries preserve for Motorola Europe and Motorola Inc. certain exclusive rights for copyrighted computer programmes, including the right to copy or reproduce in any form the copyrighted computer programme. Accordingly, any copyrighted computer programmes contained in the products described in this manual may not be copied or reproduced in any manner without the express written permission of the holders of the rights. Furthermore, the purchase of these products shall not be deemed to grant either directly or by implication, estoppel, or otherwise, any licence under the copyrights, patents, or patent applications of the holders of the rights, except for the normal non-exclusive royalty free licence to use that arises by operation of the law in the sale of the product.

## RADIO OVERVIEW

### Radio Controls



The numbers below refer to the illustrations on the inside front and rear covers.

1. **Push-to-talk (PTT)**  
Press and hold down this button to talk; release it to listen.
2. **On-Off / Volume Knob**  
Used to turn the radio on or off, and to adjust the radio's volume.
3. **Channel Selector Knob**  
Used to switch the radio to different channels.
4. **LED Indicators**  
Indicate radio status:  
**Green:** Solid during power up routine; off after successful power up; flashing when scanning.  
**Red:** Solid - transmitting; Flashing when transmitting - low battery;  
Flashing - channel is busy receiving.  
**Yellow:** Solid when radio is in monitor mode, or is sending a selective call or call alert;  
Flashing - receiving a selective call or call alert.
5. **Microphone/Speaker**  
Hold the microphone 2.5 to 5 cm (1-2 inches) from your mouth, and speak clearly into it.

### *CP140 Radios*







6. **Side Button 1**
7. **Side Button 2**
8. **Accessory Connector**  
Connects remote microphones, remote earphones and other accessories. Replace dust cap when not in use.
9. **Belt Clip**

### *CP160/CP180 Radios*

6. **LCD Display**  
An 8 character single line display with up to 9 radio status icons.
  7. **Front Button P2** 
  8. **Menu Scroll Buttons** 
  9. **Front Button P1** 
  10. **Side Button 2**
  11. **Side Button 1**
  12. **Accessory Connector**  
Connects remote microphones, remote earphones and other accessories. Replace dust cap when not in use.
  13. **Belt Clip**
- CP180 Radio Only*
14. **DTMF Keypad**

## Audio Signal Tones

High pitched tone  Low pitched tone

Signal	Description
	Self Test Pass Tone.
	Self Test Fail Tone.
	Positive Indicator Tone.
	Negative Indicator Tone.
	Good key press.
	Bad key press.

## Programmable Buttons

Several of your radios keys and buttons can be programmed, by Customer Programming Software (CPS), as short-cut buttons for many of the radio's features. Programmable buttons include:

### CP160/CP180

- The two side buttons (S1 and S2)
- The two front buttons (P1 and P2)

### CP140

- The two side buttons (S1 and S2)

Each button is dual function; a short press may select one function, a long press may select the second.

Check with your dealer for a complete list of the functions your radio supports.

## Menu Buttons (CP160/CP180)



### Menu Select Button

The  button is dedicated to Menu access and menu option selections.

### Menu Exit Button



In Menu Mode, this button is automatically assigned to exit the menu. A long press exits the menu immediately, while short presses are used to move up to the next higher Menu level. When the top level menu is selected, a short press will exit the Menu Mode.

The radio also exits the Menu Mode after an “Inactivity Time” timeout

Once the menu mode is exited, both  and  buttons return to their normal programmable condition.

### Menu Scroll Buttons

Used to scroll when in Menu Mode.

 or  to scroll through menu options. If you scroll past the last option the selection wraps around and starts again. On reaching the required option, a short press of  selects the option.

Refer to the menu navigation chart for menu selectable features.

# MENU NAVIGATION CHART (CP160/CP180)

(Refer to Menu Navigation guidelines—  
lower, left-hand corner of this page)

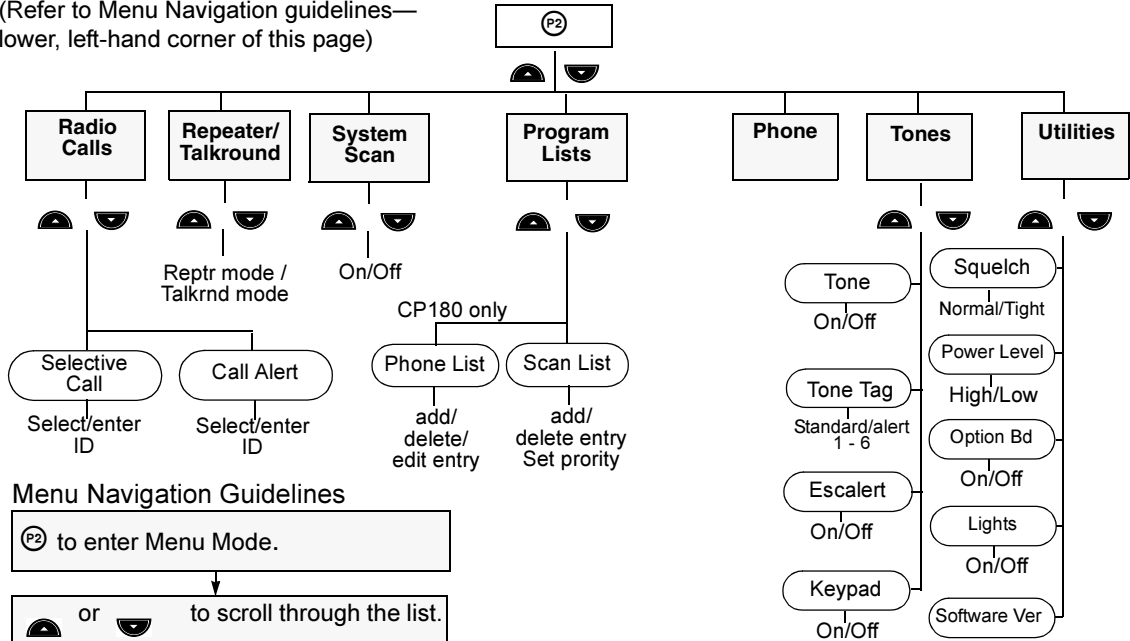

## Menu Navigation Guidelines

**P2** to enter Menu Mode.

or to scroll through the list.

**P2** to select Menu item

or to scroll through the Menu sub-list.

**P1** return to previous menu level or  
Hold down **P1** to exit Menu Mode

**P2** to select sub-menu item.

## LCD DISPLAY AND ICONS (CP160/CP180)

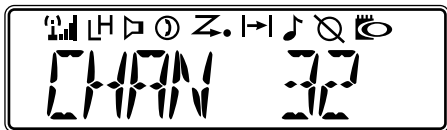

Displays radio Status, Addresses or Channel, on one line of 8 characters. The top line of the display shows radio status icons, explained in the table below:

Symbol	Name and Description
	<b>Option Board Indicator</b> Indicates that an option board is activated in the radio.
	<b>Signal Strength Indicator</b> The more bars, the stronger the signal being received by your radio.
	<b>Power Level Indicator</b> “L” lights when your radio is configured to transmit in Low Power. “H” lights when your radio is configured to transmit in High Power.
	<b>Monitor Indicator</b> The selected channel is being monitored.

Symbol	Name and Description
	<b>Scan Indicator</b> Indicates that the scan feature is activated.
	<b>Priority Scan Indicator</b> Indicates that the scan feature is activated. The dot is flashing during priority scan mode when scan has landed on a Priority 1 channel. The dot is steady during priority scan mode when scan has landed on a Priority 2 channel.
	<b>Phone Indicator</b> Phone mode is selected.
	<b>Call Received Indicator</b> A Selective Call or Call Alert has been received.
	<b>Talkaround Indicator</b> You are transmitting directly to another radio, not via a repeater.
	<b>Keypad Lock</b> The keypad has been locked.

**Note:** At extremely low temperatures, you may experience a slight delay in displaying new information. This is normal and does not affect the function of your radio.

## GETTING STARTED

### BATTERY INFORMATION

#### Charging Your Battery

If a battery is new, or its charge level is very low, you will need to charge it before you can use it. When the battery level is low and the radio is in transmit mode you will see the LED indicator flash red. Upon release of the PTT button, you will hear an alert tone.

**Note:** Batteries are shipped uncharged from the factory. Always charge a new battery 14 to 16 hours before initial use, regardless of the status indicated by the charger.

#### Desktop Charger

To Charge the Battery

- 1 Turn the radio off.
- 2 Place the battery, with or without the radio, in the charger pocket.
  - The charger LED indicates the charging progress.

LED color	Status
No LED Indication	Battery inserted incorrectly or battery not detected.
Single Green Flash	Successful charger power-up.
Flashing Red <sup>a</sup>	Battery unchargeable or not making proper contact.
Red	Battery is charging.
Flashing Yellow	Battery in charger but waiting to be charged. The battery temperature may be too hot or too cold. The voltage may be lower than the predetermined threshold level for charging.
Flashing Green <sup>b</sup>	Battery 90% (or more) charged.
Green	Battery fully charged.

- a Remove and replace the battery in the charger. If the LED indicator continues to flash red, consult your dealer.
- b A standard battery may require 90 minutes to charge to 90% capacity.

## ACCESSORY INFORMATION

### Attaching the Battery

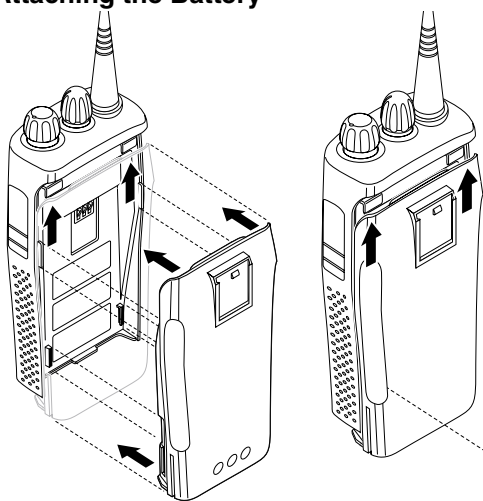

- 1 Align the battery to the battery rails on the back of the radio (approximately 1 cm from the top of the radio.)
- 2 Press the battery firmly to the radio and slide the battery upward until the latch snaps into place.
- 3 Slide the battery latch, located on radio bottom, into the lock position.

### Removing the Battery

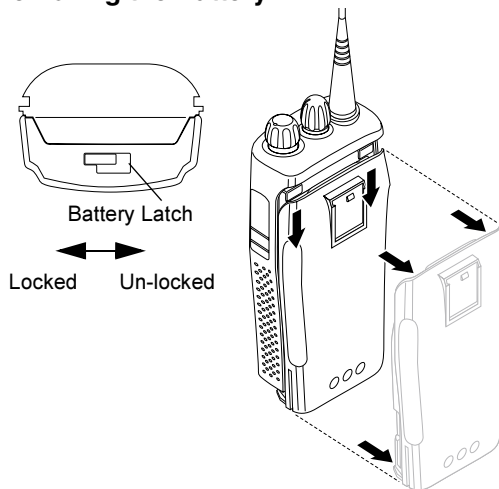

- 1 Turn off the radio if it is turned on.
- 2 Slide the battery latch into the unlock position. Disengage by pushing downward and holding the latch towards the front of the radio.
- 3 With the battery latch disengaged, slide the battery down from the top of the radio approximately 1 cm. Once the battery is free from the battery rails, lift it directly away from the radio.

## Attaching the Antenna

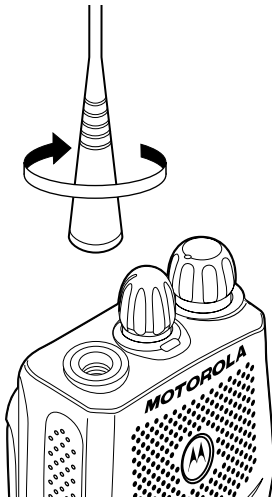

Turn the antenna clockwise to attach it.

## Removing the Antenna

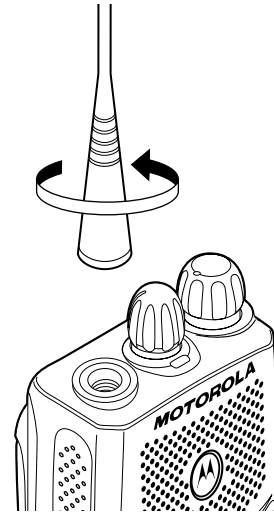

Turn the antenna counter-clockwise to remove it.

## Attaching the Belt Clip

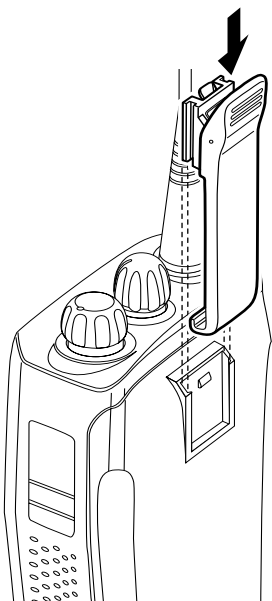

- 1 Align the grooves of the belt clip with those of the battery.
- 2 Press the belt clip downward until you hear a click.

## Removing the Belt Clip

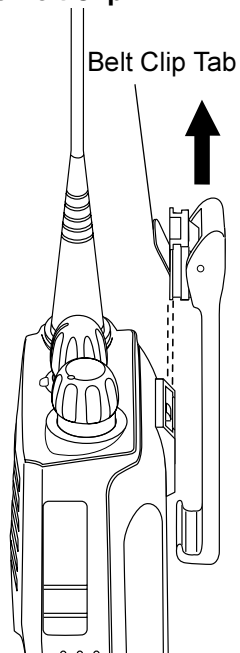

- 1 Use a key to press the belt clip tab away from the battery to unlock the belt clip.
- 2 Slide the belt clip upward to remove it.

## TURNING THE RADIO ON/OFF

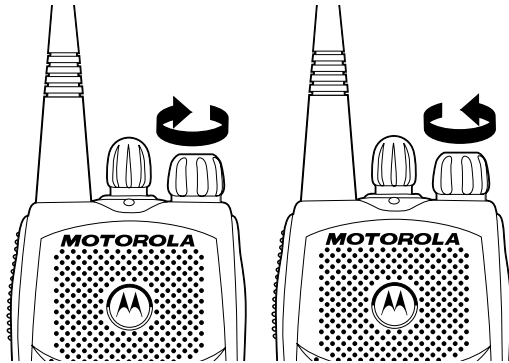

ON	OFF
Rotate the <b>On/Off/Volume Control</b> knob clockwise until you hear a click.	Rotate the <b>On/Off/Volume Control</b> knob counterclockwise until you hear a click. The display clears and the LED indicators turn off.

## Adjusting the Volume

Turn the **On/Off/Volume Control** knob clockwise to increase the volume, or counterclockwise to decrease the volume.

—or— use the pre-programmed **Volume Set** button:

- 1 Hold down the **Volume Set** button. You will hear a continuous tone.
- 2 Turn the **On/Off/Volume Control** knob to the desired volume level.
- 3 Release the **Volume Set** button.

## Radio On Message (CP160/CP180)

At power up the radio may display a message customised by your dealer, e.g.:

RADIO ON

After this text has been displayed, the radio performs a self test routine. During the routine the Green LED lights. On completion of a successful self test the radio produces the Self-Test pass Tone, the Green LED indicator goes out and the display shows the channel that was in use at power down, typically:

CHAN 32

This may be a number or an alias and will be the current channel.

## Radio On Indication (CP140)

At power up the radio performs a self test routine. During the routine the Green LED lights. On completion of a successful self test the radio produces the Self-Test pass Tone, the Green LED indicator goes out. If the radio fails the power up routine the power up fail tone sounds.

**Note:** If your radio fails the self test routine consult your dealer.

## Selecting a Radio Channel

Your radio offers up to 64 channels (CP180), 32 channels (CP160) or 16 channels (CP140), however some may not be programmed. Check with your dealer for more information.

To select a channel, turn the **Channel Selector** knob clockwise or counter clockwise until you reach the desired channel.

## Using Home Revert Memory Channels (1&2)

Two of the programmable buttons may be pre-programmed by your dealer as Memory Channel buttons, allowing you quick access to frequently used channels. A press of the button will take you to the assigned channel.

## Receiving a Call

- 1 Turn your radio on.
- 2 Adjust the radio's volume.
- 3 Select the desired channel.
- 4 Listen for voice activity. The LED indicator flashes red while your radio is receiving.
- 5 To respond, hold the radio vertically 2.5 to 5 cm (1 to 2 inches) from your mouth. Press the **PTT** to talk; release it to listen

**Note:** The system may have a limited call time and the call may be terminated automatically if this call time is exceeded.

## Sending a Call

- 1 Turn your radio on.
- 2 Select the desired channel.
- 3 Monitor for traffic (using the pre-programmed **Monitor** button) before transmitting to ensure that you do not 'talk over' someone who is already transmitting.
- 3 Hold the radio vertically 2.5 to 5 cm (1 to 2 inches) from your mouth. Press the **PTT** to talk; release it to listen.

**Note:** Your radio may be configured for 'Transmit Inhibit' under certain conditions (e.g. when the channel is in use by others) in which case, the channel busy tone will sound when you press the PTT or call button to indicate that transmission is inhibited.

## Making a Selective Call (CP160/CP180)

You can make a selective call to a particular radio, known as an individual call, or a group of radios, known as a group call.

You can make calls by using the **Menu**, the pre-programmed **Radio Call** button or **Entering a valid DTMF digit** (0-9) to move to that location in the pre-programmed list using the DTMF keypad (CP180 only).

## Receiving a Selective Call

When you receive a selective call, the LED indicator flashes yellow (if programmed by your dealer) and you will hear two high pitched tones.

On CP160 and CP180 radios the display shows  and the pre-programmed name or ID of the calling radio.

To acknowledge the call, press and release the **PTT** button.

Press and hold the **PTT** button to talk; release to listen.

## Cancelling a Call

At any time while setting up a call, it may be cancelled by pressing the Monitor button.

The call timer can also cancel a call.

## Ending a Call

A call should always be ended by pressing the Monitor button.